



Alufab Inc.

1018 Seabrook Way Cincinnati, OH 45245
Toll Free: 1-888-646-6097
Phone: 513.528.7281 Fax: 513.528.4705
www.alufabinc.com

05 | DYNAMIC & STRUCTURAL HINGES

Dynamic hinges are made of 6000 series aluminum alloy with pre-lubricated bronze pivot bearings and hardened stripper bolt axles. The dynamic hinges are designed to give your design from 0 to 180 degrees of axial motion. Dynamic hinges are great for diverter gate applications and have a high load capacity.

Dynamic & Structural Hinges

10 S STRUCTURAL & DYNAMIC PIVOT JOINT 10S 25S



ITEM #	DESCRIPTION
664084	10 S / 25 S Pivot Joint
664085	10 S / 25 S Pivot Joint w/ Locking Handle

- Bushing enables pivot to be both structural and dynamic
- Locating pins can be removed to accommodate both extrusion end and side mount assembly

» *The 2 parts can replace all other 10 S hinges.*

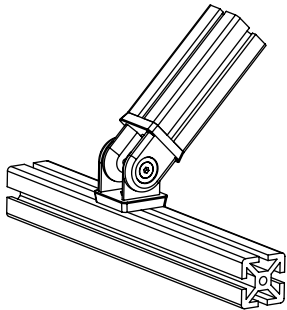
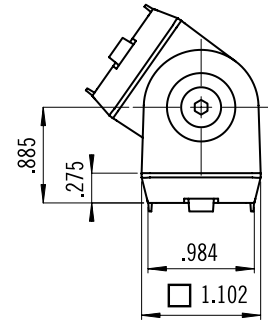

RECOMMENDED SLOT FASTENERS (TO EXTRUSION SLOT)

ITEM #	DESCRIPTION
651235	1/4-20 x 1/2" SHCS & Economy T-Nut
651334 & 651386	M6 x 16mm SHCS & Economy T-Nut

RECOMMENDED END FASTENERS (TO EXTRUSION END)

ITEM #	DESCRIPTION
651027	1/4-20 x 3/4" SHCS
651337	M6 x 20mm SHCS

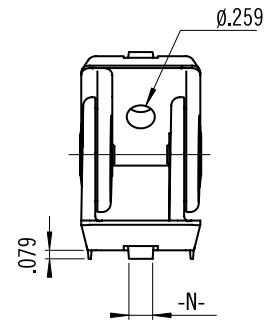

15 S STRUCTURAL & DYNAMIC PIVOT JOINT 15S 40S



ITEM #	DESCRIPTION
664086	15 S Pivot Joint
664087	15 S Pivot Joint w/ Locking Handle

- Bushing enables pivot to be both structural and dynamic
- Locating pins can be removed to accommodate both extrusion end and side mount assembly

» *The 2 parts can replace all other 15 S hinges.*

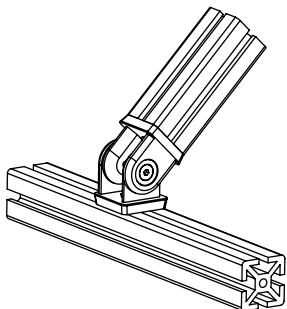
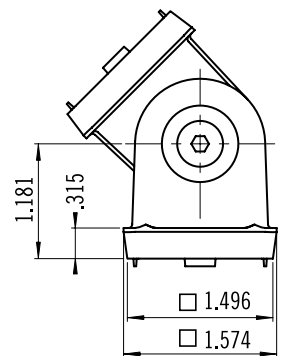

RECOMMENDED SLOT FASTENERS (TO EXTRUSION SLOT)

ITEM #	DESCRIPTION
651201	5/16-18 x 5/8" SHCS & Economy T-Nut
651512	M8 x 16mm SHCS & Economy T-Nut

RECOMMENDED END FASTENERS (TO EXTRUSION END)

ITEM #	DESCRIPTION
651052	5/16-18 x 3/4" SHCS
651346	M8 x 20mm SHCS

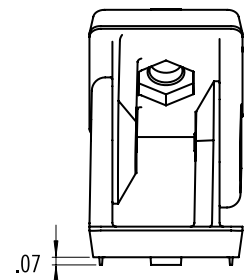















05:02

10 SERIES DYNAMIC HINGES 10S 25S

INCLUDED BOLT ASSEMBLY - For arm to extrusion















QTY	FOR ITEM #	DESCRIPTION
2	653114	1/4-20 x 1/2" FBHSCS & Double Economy T-Nut
4	653105	1/4-20 x 1/2" FHSCS & T-Nut

		IND PART NUMBERS				
		 653111	 653113	 653108	 653114	 653105
ASSEMBLY PART NUMBERS	 653110	1			2	
	 653112		1		2	
	 653109			1	2	
	 653101	1				2
	 653102		1			2
	 653104			1		2
	 653095	1			1	1
	 653096		1		1	1
 653097			1	1	1	

15 SERIES DYNAMIC HINGES 15S

INCLUDED BOLT ASSEMBLY - For arm to extrusion

QTY	FOR ITEM #	DESCRIPTION
2	653211	5/16-18 x 5/8" FBHSCS & Double Economy T-Nut
4	653176	5/16-18 x 5/8" FHSCS & T-Nut

		IND PART NUMBERS				
		 653208	 653210	 653205	 653211	 653176
ASSEMBLY PART NUMBERS	 653207	1			2	
	 653209		1		2	
	 653206			1	2	
	 653154	1				2
	 653155		1			2
	 653156			1		2
	 653195	1			1	1
	 653196		1		1	1
 653147			1	1	1	

Dynamic & Structural Hinges

0° LIVING NUB

10S 25S 10 S Item Number: **653111**

15S 15 S Item Number: **653208**



PIVOT BOLT ASSEMBLY - Recommended bolt assembly to extrusion

ITEM #	DESCRIPTION
651244	5/16 x 1/4 Stripper Bolt & Thrust Washer (10 S)
651243	3/8 x 3/8 Stripper Bolt & Thrust Washer (15 S)

FASTENERS INCLUDED

15 S	(1) 5/16-18 x 1 1/2" SHCS and Economy T-Nut
10 S	(1) 1/4-20 x 1" SHCS and Economy T-Nut

ITEM #	LBS	A	B	C	E	F	G
653111	.070	1.00	.937	1.00	1/4-20 SHCS	.50	1/4-20X.50
653208	.325	1.50	1.437	1.50	5/16-18 SHCS	.75	5/16-18X.75

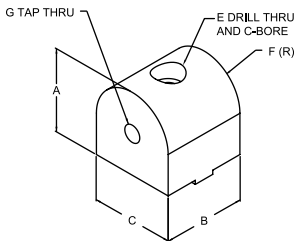

» See page 05:02 for assemblies.

05:04

90° LIVING NUB

10S 25S 10 S Item Number: **653113**

15S 15 S Item Number: **653210**



PIVOT BOLT ASSEMBLY - Recommended bolt assembly to extrusion

ITEM #	DESCRIPTION
651244	5/16 x 1/4 Stripper Bolt & Thrust Washer (10 S)
651243	3/8 x 3/8 Stripper Bolt & Thrust Washer (15 S)

FASTENERS INCLUDED

15 S	(1) 5/16-18 x 1 1/2" SHCS and Economy T-Nut
10 S	(1) 1/4-20 x 1" SHCS and Economy T-Nut

ITEM #	LBS	A	B	C	E	F	G
653113	.070	1.00	.937	1.00	1/4-20 SHCS	.50	1/4-20X.50
653210	.325	1.50	1.437	1.50	5/16-18 SHCS	.75	5/16-18X.75

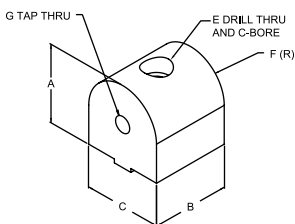

» See page 05:02 for assemblies.

UNIVERSAL LIVING NUB

10S 25S 10 S Item Number: **653108**

15S 15 S Item Number: **653205**



PIVOT BOLT ASSEMBLY - Recommended bolt assembly to extrusion

ITEM #	DESCRIPTION
651244	5/16x1/4 Stripper Bolt & Thrust Washer (10 S)
651243	3/8x3/8 Stripper Bolt & Thrust Washer (15 S)

FASTENERS INCLUDED

15 S	(2) 5/16-18 x 1 1/2" SHCS and Economy T-Nut
10 S	(2) 1/4-20 x 1" SHCS and Economy T-Nut

ITEM #	LBS	A	B	C	D	E	F	G
653108	.145	1.00	1.937	1.00	1.00	1/4-20 SHCS	.50	1/4-20X.50
653205	.325	1.50	2.937	1.50	1.50	5/16-18 SHCS	.75	5/16-18X.75

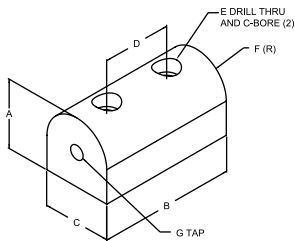

» See page 05:02 for assemblies.

STRAIGHT PIVOT ARM

10S 25S 10 S Item Number: **653114**

15S 15 S Item Number: **653211**



PIVOT BOLT ASSEMBLY - Recommended bolt assembly to extrusion

ITEM #	DESCRIPTION
651244	5/16 x 1/4 Stripper Bolt & Thrust Washer (10 S)
651243	3/8 x 3/8 Stripper Bolt & Thrust Washer (15 S)

FASTENERS INCLUDED

15 S	(2) 5/16-18 x 5/8" FBHSCS and Double Economy T-Nut
10 S	(2) 1/4-20 x 1/2" FBHSCS and Double Economy T-Nut

ITEM #	A	B	C	D	F	H	J	K	M
653114	.188	3.00	1.00	1.00	.50	.257	1.00	.50	.312
653211	.25	4.50	1.50	1.50	.75	.328	1.50	.75	.375

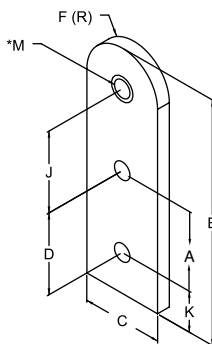

*M is the internal diameter of the permanently lubricated bronze brushing

» See page 05:02 for assemblies.

Dynamic & Structural Hinges

"L" PIVOT ARM

10S 25S 10 S Item Number: **653105**

15S 15 S Item Number: **653176**



PIVOT BOLT ASSEMBLY - Recommended bolt assembly to extrusion

ITEM #	DESCRIPTION
651244	5/16 x 1/4 Stripper Bolt & Thrust Washer (10 S)
651243	3/8 x 3/8 Stripper Bolt & Thrust Washer (15 S)

FASTENERS INCLUDED

15 S	(2) 5/16-18 x 5/8" FBHSCS and Double Economy T-Nut
10 S	(2) 1/4-20 x 1/2" FBHSCS and Double Economy T-Nut

ITEM #	LBS	A	B	C	D	F	H	J	K	M	N	P
653105	.045	.188	2.00	1.00	1.00	.50	DR + C'SINK**	.50	.50	.312	1.00	.50
653176	.145	.25	3.00	1.50	1.50	.75	DR + C'SINK**	.75	.75	.375	1.50	.75

*M is the internal diameter of the permanently lubricated bronze brushing

**653105 has a drill thru and c'sink for 1/4-20 FHSCS

**653176 has a drill thru and c'sink for 5/16-18 FHSCS

» See page 05:02 for assemblies.

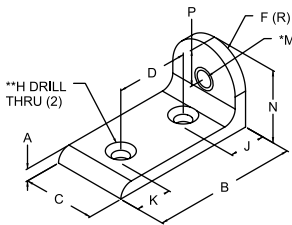

05:06

0° RIGHT ANGLE LIVING NUB

10S 25S 10 S Item Number: **653022**

15S 15 S Item Number: **653245**



PIVOT BOLT ASSEMBLY - Recommended bolt assembly to extrusion

ITEM #	DESCRIPTION
651244	5/16 x 1/4 Stripper Bolt & Thrust Washer (10 S)
651243	3/8 x 3/8 Stripper Bolt & Thrust Washer (15 S)

FASTENERS INCLUDED

15 S	(1) 5/16-18 x 1 1/2" SHCS and Economy T-Nut
10 S	(1) 1/4-20 x 1" SHCS and Economy T-Nut

ITEM #	LBS	A	B	C	E	F	G
653022	.074	1.00	.937	.468	1/4-20 SHCS	.50	1/4-20X.50
653245	.327	1.50	1.437	.718	5/16-18 SHCS	.75	5/16-18X.75

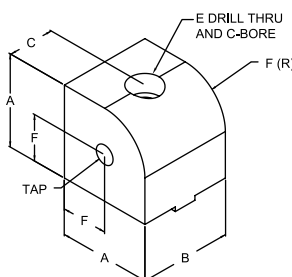

90° RIGHT ANGLE LIVING NUB

10S 25S 10 S Item Number: **653023**

15S 15 S Item Number: **653246**



ITEM #	DESCRIPTION
653023	10 S Right Angle 90° Living Nub
653246	15 S 90° Right Angle Living Nub

PIVOT BOLT ASSEMBLY - Recommended bolt assembly to extrusion

ITEM #	DESCRIPTION
651244	5/16 x 1/4 Stripper Bolt & Thrust Washer (10 S)
651243	3/8 x 3/8 Stripper Bolt & Thrust Washer (15 S)

FASTENERS INCLUDED

15 S	(1) 5/16-18 x 1 1/2" SHCS and Economy T-Nut
10 S	(1) 1/4-20 x 1" SHCS and Economy T-Nut

ITEM #	LBS	A	B	C	E	F	G
653023	.074	1.00	.937	.468	1/4-20 SHCS	.50	1/4-20X.50
653246	.327	1.50	1.437	.718	5/16-18 SHCS	.75	5/16-18X.75

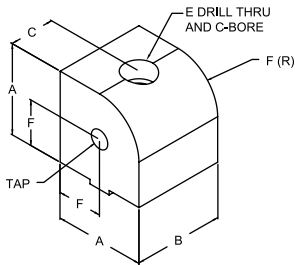

UNIVERSAL RIGHT ANGLE LIVING NUB

10S 25S 10 S Item Number: **653024**

15S 15 S Item Number: **653247**



PIVOT BOLT ASSEMBLY - Recommended bolt assembly to extrusion

ITEM #	DESCRIPTION
651244	5/16 x 1/4 Stripper Bolt & Thrust Washer (10 S)
651243	3/8 x 3/8 Stripper Bolt & Thrust Washer (15 S)

FASTENERS INCLUDED

15 S	(2) 5/16-18 x 1 1/2" SHCS and Economy T-Nut
10 S	(2) 1/4-20 x 1" SHCS and Economy T-Nut

ITEM #	LBS	A	B	C	D	E	F	G
653024	.145	1.00	1.937	.468	1.00	1/4-20 SHCS	.50	1/4-20X.50
653247	.654	1.50	2.937	.718	1.50	5/16-18 SHCS	.75	5/16-18X.75

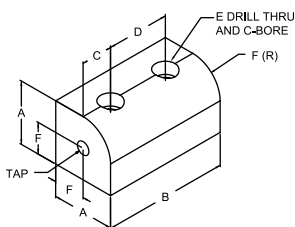

Dynamic & Structural Hinges

90° PIVOT BRACKET ASSEMBLY



ASSEMBLY	PLATE ONLY	DESCRIPTION
653076	653070	10 S 90° Left Hand Pivot Bracket 10S 25S
653082	653074	10 S 90° Right Hand Pivot Bracket 10S 25S
653172	653166	15 S 90° Pivot Bracket Left Hand 15S
653180	653170	15 S 90° Pivot Bracket Right Hand 15S

BOLT ASSEMBLY - Recommended bolt assembly to extrusion (plate to slot)

QTY	ITEM #	DESCRIPTION
3	651130	1/4-20 x 1/2" FBHSCS and Economy T-Nut (10 S)
3	651129	5/16-18 x 11/16" FBHSCS and Economy T-Nut (15 S)

- 90 Degrees of motion
- Permanently lubricated bronze bushings at high strength pivot points
- Nylon washers between plate and extrusion allow for smooth motion
- Left and Right hand versions
- 10 and 15 Series sizes
- Assembly includes "L" handle, Nub, stripper bolt and nylon washer

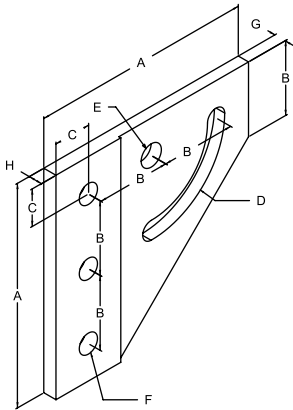

ITEM #	LBS	A	B	C	D	E	F	G	H
653070	.105	3.00	1.00	.500	.265	.312	.281	.158	.188
653074	.105	3.00	1.00	.500	.265	.312	.281	.158	.188
653166	.325	4.50	1.50	.750	.328	.375	.328	.220	.250
653170	.325	4.50	1.50	.750	.328	.375	.3328	.220	.250























05:08

10 SERIES STRUCTURAL HINGES

INCLUDED BOLT ASSEMBLY - *Extrusion to nub*
1/4-20 x 1" SHCS & Econ T-Nut

RECOMMENDED BOLT ASSEMBLY - *For arm to extrusion*

QTY	FOR ITEM #	DESCRIPTION
4	651130	1/4-20 x 1/2" FBHSCS & Economy T-Nut
2	651136	1/4-20 x 1/2" FBHSCS

		IND PART NUMBERS								
		 653116	 653117	 653115	 653083	 653119	 653000	 653001	 653002	
ASSEMBLY PART NUMBERS	 0° 653120	1				2				
	 90° 653121		1			2				
	 653118			1		2				
	 0° 653087	1			2					
	 90° 653088		1		2					
	 653090			1	2					
	RIGHT ANGLE									
	 0° 653003					2	1			
	 90° 653004					2		1		
	 653005					2			1	
	 0° 653006				2		1			
	 90° 653007				2			1		
	 653008				2				1	
	 0° 653009				1	1	1			
	 90° 653010				1	1		1		
	 653011				1	1			1	

Dynamic & Structural Hinges

10 SERIES - 0° Pivot Nub

10S 25S Item Number: 653116

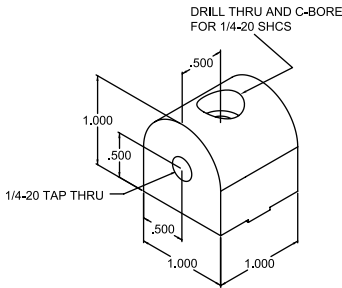

RECOMMENDED ASSEMBLY FOR ARMS

QTY	DESCRIPTION	PART#
2	1/4-20 x 1/2" Flanged BHSCS	651136

INCLUDED

1	1/4-20 x 1" SHCS & Economy T-Nut
---	----------------------------------

» See page 05:08 for assemblies.

10 SERIES - 90° Pivot Nub

10S 25S Item Number: 653117

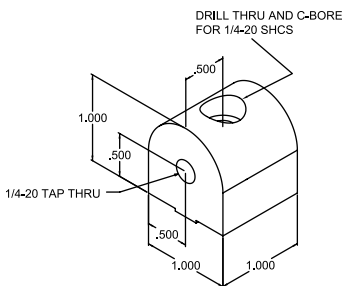

RECOMMENDED ASSEMBLY FOR ARMS

QTY	DESCRIPTION	PART#
2	1/4-20 x 1/2" Flanged BHSCS	651136

INCLUDED

1	1/4-20 x 1" SHCS & Economy T-Nut
---	----------------------------------

» See page 05:08 for assemblies.

10 SERIES - 2" Universal Pivot Nub

10S 25S Item Number: 653115

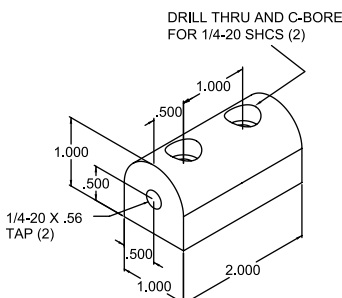

RECOMMENDED ASSEMBLY FOR ARMS

QTY	DESCRIPTION	PART#
2	1/4-20 x 1/2" Flanged BHSCS	651136

INCLUDED

2	1/4-20 x 1" SHCS & Economy T-Nut
---	----------------------------------

» See page 05:08 for assemblies.

05:10

10 SERIES - Right Angle 0° Pivot Nub

10S 25S Item Number: 653000

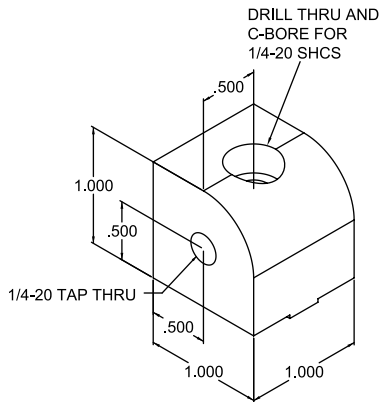

RECOMMENDED ASSEMBLY FOR ARMS

QTY	DESCRIPTION	PART#
2	1/4-20 x 1/2" Flanged BHSCS	651136

INCLUDED

1	1/4-20 x 1" SHCS & Economy T-Nut
---	----------------------------------

» See page 05:08 for assemblies.

10 SERIES - Right Angle 90° Pivot Nub

10S 25S Item Number: 653001

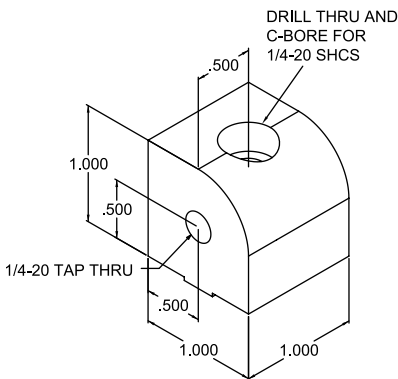

RECOMMENDED ASSEMBLY FOR ARMS

QTY	DESCRIPTION	PART#
2	1/4-20 x 1/2" Flanged BHSCS	651136

INCLUDED

1	1/4-20 x 1" SHCS & Economy T-Nut
---	----------------------------------

» See page 05:08 for assemblies.

10 SERIES - Right Angle Universal Pivot Nub

10S 25S Item Number: 653002

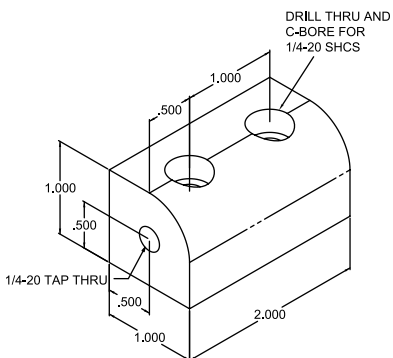

RECOMMENDED ASSEMBLY FOR ARMS

QTY	DESCRIPTION	PART#
2	1/4-20 x 1/2" Flanged BHSCS	651136

INCLUDED

2	1/4-20 x 1" SHCS & Economy T-Nut
---	----------------------------------

» See page 05:08 for assemblies.

Dynamic & Structural Hinges

10 SERIES - "L" Pivot Arm

10S 25S Item Number: 653083

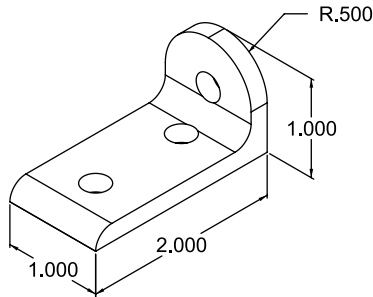

RECOMMENDED FASTENERS

QTY	DESCRIPTION	PART#
3	1/4-20 x 1/2" BHSCS & Economy T-Nut	651171

» See page 05:08 for assemblies.

10 SERIES - 3" Pivot Arm

10S 25S Item Number: 653119

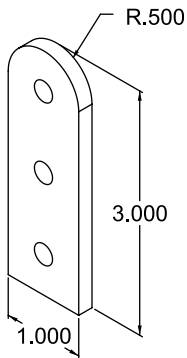

RECOMMENDED FASTENERS

QTY	DESCRIPTION	PART#
3	1/4-20 x 1/2" BHSCS & Economy T-Nut	651171

» See page 05:08 for assemblies.

10 SERIES - 4" Pivot Arm

10S 25S Item Number: 653122

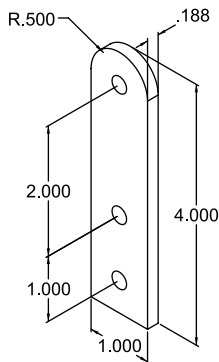

RECOMMENDED FASTENERS

QTY	DESCRIPTION	PART#
3	1/4-20 x 1/2" FBHSCS & Economy T-Nut	651130

» See page 05:08 for assemblies.



























05:12

15 SERIES STRUCTURAL HINGES 15S

INCLUDED BOLT ASSEMBLY - *Extrusion to nub*
5/16-18 x 1/2" SHCS & Econ T-Nut

RECOMMENDED BOLT ASSEMBLY - *For arm to extrusion*

QTY	FOR ITEM #	DESCRIPTION
4	651129	5/16-18 x 11/16" FBHSCS & Econ T-Nut
2	651134	5/16-18 x 11/16" FBHSCS

		IND PART NUMBERS								
		 653213	 653214	 653212	 653181	 653219	 653223	 653224	 653225	
ASSEMBLY PART NUMBERS	 0° 653220	1				2				
	 90° 653221		1			2				
	 653218			1		2				
	 0° 653185	1			2					
	 90° 653186		1		2					
	 653188			1	2					
	 0° 653189	1			1	1				
	 90° 653190		1		1	1				
	 653191			1	1	1				
	RIGHT ANGLE									
	 0° 653226						2	1		
	 90° 653227						2		1	
	 653228						2			1
	 0° 653229					2		1		
	 90° 653230					2			1	
	 653231					2				1
	 0° 653232					1	1	1		
	 90° 653233					1	1		1	
	 653234					1	1			1

Dynamic & Structural Hinges

15 SERIES - 0° Pivot Nub

Item Number: **653213**

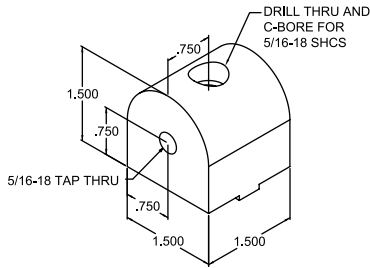

RECOMMENDED ASSEMBLY FOR ARMS

QTY	DESCRIPTION	PART#
2	5/16-18 x 11/16" Flanged BHSCS	651134

INCLUDED

1	5/16x1 1/2" SHCS & Economy T-Nut	
---	----------------------------------	--

» See page 05:12 for assemblies.

15 SERIES - 90° Pivot Nub

Item Number: **653214**

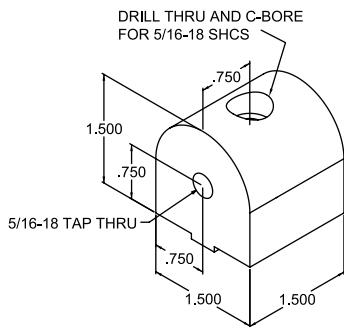

RECOMMENDED ASSEMBLY FOR ARMS

QTY	DESCRIPTION	PART#
2	5/16-18 x 11/16" Flanged BHSCS	651134

INCLUDED

1	5/16x1 1/2" SHCS & Economy T-Nut	
---	----------------------------------	--

» See page 05:12 for assemblies.

15 SERIES - 3" Universal Pivot Nub

Item Number: **653212**

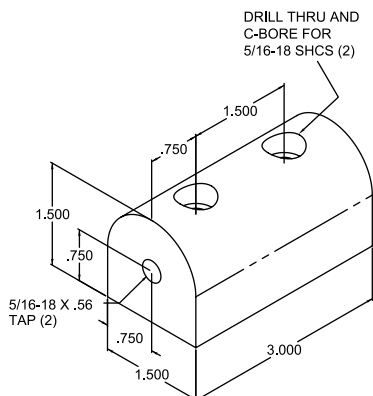

RECOMMENDED ASSEMBLY FOR ARMS

QTY	DESCRIPTION	PART#
2	5/16-18 x 11/16" Flanged BHSCS	651134

INCLUDED

2	5/16x1 1/2" SHCS & Economy T-Nut	
---	----------------------------------	--

» See page 05:12 for assemblies.

05:14

15 SERIES - Right Angle 0° Pivot Nub

Item Number: 653223

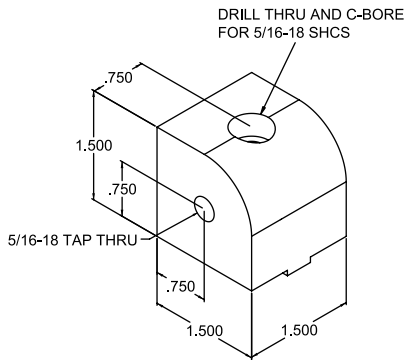

RECOMMENDED ASSEMBLY FOR ARMS

QTY	DESCRIPTION	PART#
2	5/16-18 x 11/16" Flanged BHSCS	651134

INCLUDED

1	5/16-18 x 1 1/2" SHCS & Economy T-Nut
---	---------------------------------------

» See page 05:12 for assemblies.

15 SERIES - Right Angle 90° Pivot Nub

Item Number: 653224

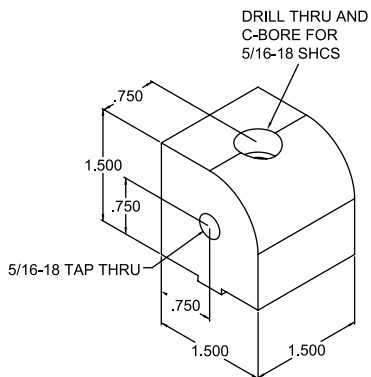

RECOMMENDED ASSEMBLY FOR ARMS

QTY	DESCRIPTION	PART#
2	5/16-18 x 11/16" Flanged BHSCS	651134

INCLUDED

1	5/16-18 x 1 1/2" SHCS & Economy T-Nut
---	---------------------------------------

» See page 05:12 for assemblies.

15 SERIES - Right Angle 3" Universal Pivot Nub

Item Number: 653225

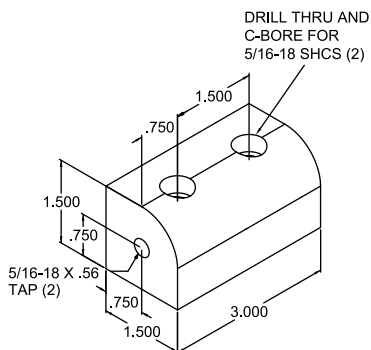

RECOMMENDED ASSEMBLY FOR ARMS

QTY	DESCRIPTION	PART#
2	5/16-18 x 11/16" Flanged BHSCS	651134

INCLUDED

2	5/16-18 x 1 1/2" SHCS & Economy T-Nut
---	---------------------------------------

» See page 05:12 for assemblies.

Dynamic & Structural Hinges

15 SERIES - "L" Pivot Arm

Item Number: **653181**

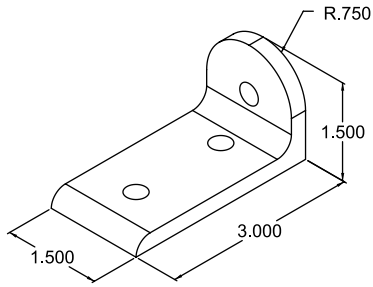

RECOMMENDED FASTENERS

QTY	DESCRIPTION	PART#
3	5/16-18 x 11/16" FBHSCS & Economy T-Nut	651129

» See page 05:12 for assemblies.

15 SERIES - 4.5" Pivot Arm

Item Number: **653219**

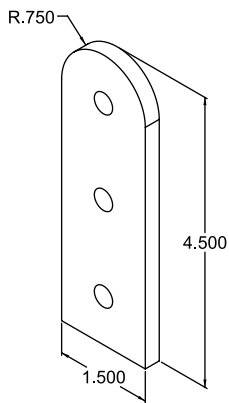

RECOMMENDED FASTENERS

QTY	DESCRIPTION	PART#
3	5/16-18 x 11/16" FBHSCS & Economy T-Nut	651129

» See page 05:12 for assemblies.

15 SERIES - 6" Pivot Arm

Item Number: **653222**

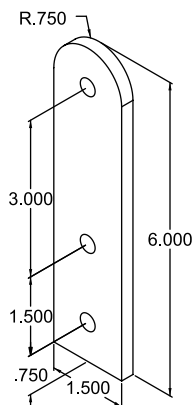

RECOMMENDED FASTENERS

QTY	DESCRIPTION	PART#
3	5/16-18 x 11/16" Flanged BHSCS	651134

» See page 05:12 for assemblies.

05:16